

TM

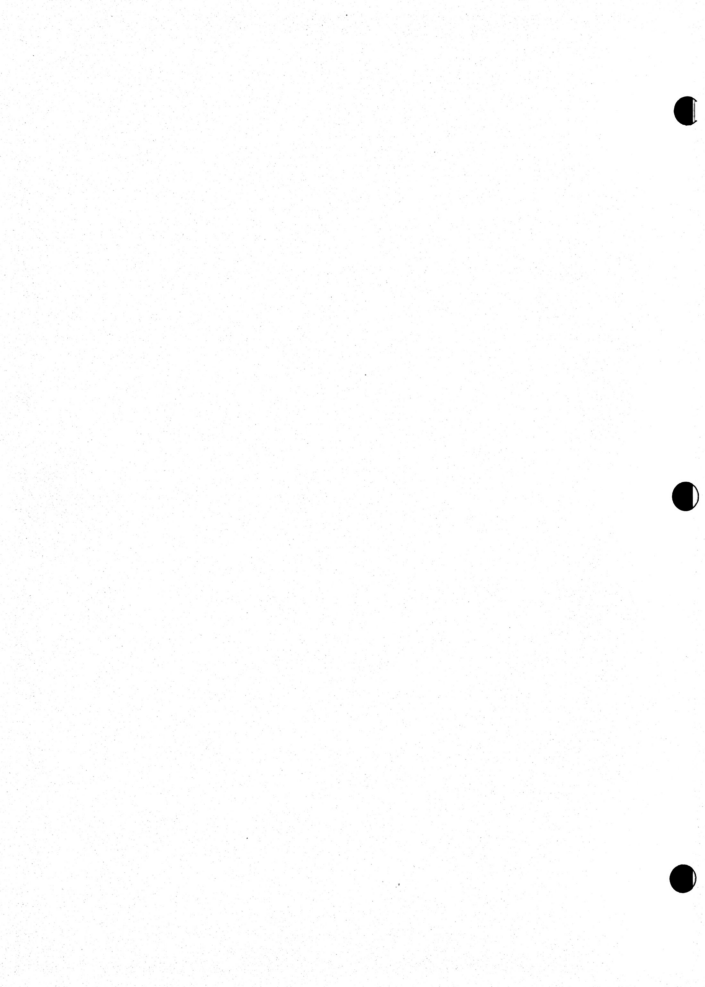

MANUAL

©1983 Exidy, Inc.





**OPERATORS  
MANUAL**

*Preliminary*

©1983 Exidy, Inc.

390 Java Drive, Sunnyvale, California 94089-1271

Telephone: (408) 734-9410 Toll-free: (800) 538-8402

Telex: 357-499 (EXIDY MNTV)





## PROPRIETARY NOTICE

The contents of this manual are the property of EXIDY, INC. not to be copied or reproduced in any manner whatsoever, nor disseminated in any form to any person who is not a Crossbow user without the permission of EXIDY.

## **COPYRIGHT**

Copyright ©1983 by EXIDY, INC. All rights reserved. No part of this publication may be reproduced, transmitted, transcribed, stored in a retrieval system, or translated into any language in any form, or by any means without the prior written permission of EXIDY, INC. 390 Java Drive, Sunnyvale, California 94089.

## **DISCLAIMER**

EXIDY, INC. makes no representations or warranties with respect to the contents hereof and specifically disclaims any implied warranties of merchantability or fitness for any particular purpose. Further, Exidy, Inc. reserves the right to revise this publication from time to time in the content hereof without obligation of Exidy, Inc. to notify any person of such revision or changes.

## **TRADEMARKS**

**Crossbow™** is a trademark of Exidy, Inc.



## WARNING

This equipment generates, uses and can radiate radio frequency energy and if not installed and used in accordance with the instruction manual, may cause interference to radio communications. It has been tested and found to comply with the limits for a Class A computing device pursuant to Subpart J of Part 15 of FCC Rules which are designed to provide reasonable protection against such interference when operated in a commercial environment. Operation of this equipment in a residential area is likely to cause interference in which case the user at his own expense will be required to take whatever measure may be required to correct the interference.

## QUESTIONS

EXIDY encourages technicians to use the toll-free customer service hotline for any questions they may have regarding Crossbow™. That number is (800) 538-8402.



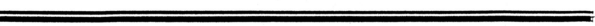



## TABLE OF CONTENTS

### 1 GAME SET-UP

GENERAL .....	1-2
INSPECTION .....	1-3
INSTALLATION .....	1-4
PRELIMINARY CHECK OUT PROCEDURE .....	1-5
OPERATOR OPTION SWITCHES .....	1-6

### 2 GAME DESCRIPTION

GENERAL .....	2-2
ATTRACT MODE .....	2-3
READY-TO-PLAY .....	2-3
PLAY MODE .....	2-3

### LIST OF ILLUSTRATIONS

<b>FIGURE 1-1</b>	<b>MAJOR COMPONENT LOCATIONS .....</b>	<b>1-2</b>
	<b>PCB ASSEMBLY LOCATIONS .....</b>	<b>1-2</b>
	<b>REAR ACCESS PANEL .....</b>	<b>1-2</b>
<b>FIGURE 1-2</b>	<b>CROSSBOW™ INSTALLATION .....</b>	<b>1-4</b>
<b>FIGURE 1-3</b>	<b>VOLUME CONTROL ADJUSTMENT .....</b>	<b>1-7</b>
	<b>OPERATOR OPTION SWITCH SETTINGS .....</b>	
<b>FIGURE 2-1</b>	<b>PLAY MODE DISPLAY .....</b>	<b>2-3</b>

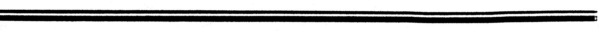



## Game Set Up



## INSPECTION

All EXIDY equipment is carefully packaged in well-padded cardboard containers to prevent damage during shipment. Before signing the delivery receipt, you should follow this procedure:

1. Check for obvious damage and make certain that the physical piece count of the shipment matches the piece on the bill of lading. These two procedures should always be done before signing the delivery receipt.
2. Shortages and/or obvious damage to the packaging on any given shipment should be noted in writing on the delivery receipt before signing for the delivery.
3. If concealed damage is suspected on any shipment, those packages believed to contain the damaged goods should be opened in the presence of the delivery driver. If the goods have sustained concealed damage, a description of said damage should be noted in writing on the delivery receipt before signing for the delivery.
4. Never apply power to any game with noticeable damage.
4. The sooner a claim is filed, the better for all parties concerned. The carrier against which a claim is filed is required, by law, to respond to (acknowledge) that claim within thirty (30) days of receiving same and must reach a final disposition in the matter within one hundred twenty (120) days.

## VISUAL INSPECTION

1. Remove the rear and front access doors with the appropriate packaged key. (*ref. Fig. 1-1.*)
2. Examine each major and electrical component thoroughly for scrapes, dents, broken or missing parts and loose or missing screws.
3. Check for loose cable connectors.
4. Visually verify that all the integrated circuit devices (IC's) plugged into sockets are properly seated.

## FILING A CLAIM

TO FILE A CLAIM, FOLLOW THIS PROCEDURE:

1. Any and all damaged freight, including packaging, should be retained by the consignee until a physical inspection of said freight can be made by a representative of the carrier involved.
2. The Claims Manager for the carrier involved should be notified as soon as possible, after the damaged goods are received. Preferably, the carrier's Claims Manager should be notified within forty-eight (48) hours of receipt of the goods by the consignee.
3. If warranted, a written claim should be filed with the carrier involved. A detailed description of the damage(s) should be provided and copies of all supporting documents, including bill of lading and/or delivery receipt, inspection report, and invoice, should be attached.

*If you find any damage during this inspection, file a claim with the carrier. Send a complete report of the damage to EXIDY, INC.*

## INSTALLATION

Planning the location of the game should involve both physical and electrical considerations.

Such physical considerations concern the placement of the equipment with respect to these clearances:

HEIGHT: 80.00 inches, 203.2 cm.

WIDTH: 25.25 inches, 65.1 cm.

DEPTH: 35.00 inches, 88.9 cm.

An indoor, relatively dust-free environment is necessary, with proper conditions required of any electrical device. Electrical considerations include availability of an AC outlet with the correct voltage and frequency. You should consider the working space required for technicians and operators including access to the rear of the game.

### NOTE:

The cabinet must be within seven feet of an AC outlet. Be certain that a ground jack or terminal is available at the outlet.

### CAUTION:

DO NOT remove the AC ground prong from the plug. Doing so may cause electrical shock.

### Crossbow™

The Crossbow is detached from Mounting for shipping. Locate Crossbow Stock and mount with three (3) mounting screws as illustrated. (Ref. Fig. 1-2)

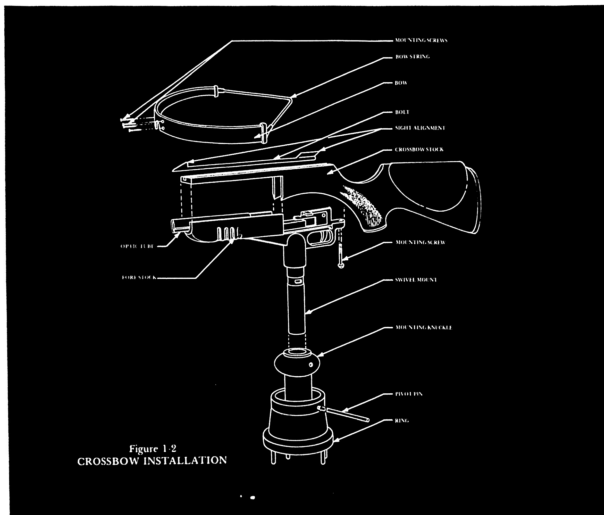

## PRELIMINARY CHECKOUT PROCEDURE

The Crossbow game, after it is properly installed, should be checked operationally by performing the following procedures:

- (a) PLUG IN THE AC JACK INTO THE AC OUTLET.
- (b) ALLOW 1 TO 2 MINUTES FOR CRT WARM-UP.

All DC Power required to operate Crossbow™ is supplied in the Exidy Power Supply Module. These supply outputs are as follows:

- +5VDC @ 9 amps
- +18VDC @ 3 amps
- -18VDC @ 3 amps

**CAUTION:** Only certified technicians should make adjustments on all components of Crossbow™. Only the +5V DC is adjustable. This must be adjusted to: +5.00V DC +/- .1V as measured on the Main Logic PCB near the 6809E Microprocessor at location J2. (Ref Fig. 1-3) Measure at pins 7 and 14 of the 74LS05.

## CROSSBOW SIGHT ALIGNMENT PROCEDURE

This alignment is only necessary whenever the crossbow is disassembled or if it would require verification.

*Proceed As Follows.*

- POWER DOWN
- POWER UP
- HOLD DOWN START BUTTON TO DISPLAY MANUAL DIAGNOSTIC MODE.
- RELEASE START BUTTON WHEN DIAGNOSTIC APPEARS

Using Start Button Index to Gun Sight Alignment Test and enter mode by pressing gun trigger. Hold down gun trigger while aiming at crosshair (+) on screen. When both sight and crosshair are aligned release trigger and return to Manual Diagnostic Mode by pressing start button, index to exit and press gun trigger. The game will now be in the ATTRACT MODE.



## AUDIO ADJUSTMENT

Locate R15 master audio gain pot located at position T2 of audio board (Ref. Fig. 1-3) and adjust audio level as game is in progress.

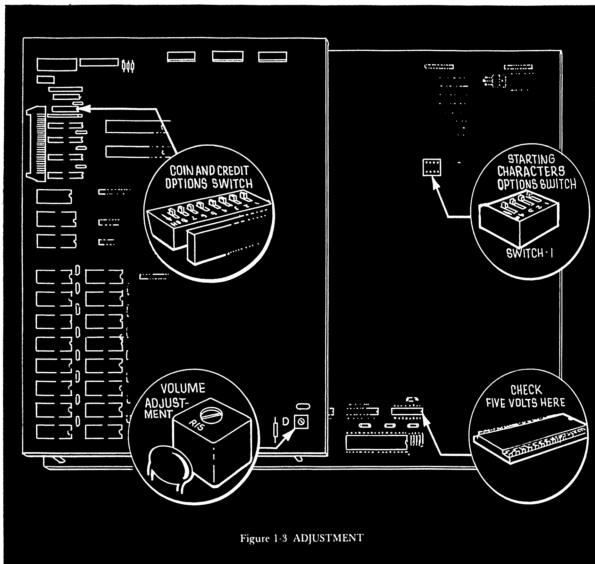

## OPERATOR OPTION SWITCH

Crossbow™ Game play has several selectable options on 8 and 4 position dip switches — Switch locations at B1 of audio board for 8 position and J19 of logic board for 4 position. Both switches are access-

able from back door of game. Factory setting of switches located at B1 & J19 are all set to off. (Ref. Fig. 1-3)

**SWITCH OPTIONS SETTINGS**  
**8 POSITION SWITCH LOCATION B1**

COIN RATIO: COIN DOOR 2 AND TO COIN DOOR 1		SWITCH NUMBERS							
		1	2	3	4	5	6	7	8
1 - 1			OFF	OFF	OFF				
2 - 1			OFF	OFF	ON				
3 - 1			OFF	ON	OFF				
4 - 1			OFF	ON	ON				
5 - 1			ON	OFF	OFF				
6 - 1			ON	OFF	ON				
7 - 1			ON	ON	OFF				
8 - 1			ON	ON	ON				
<b>FREE PLAY</b>			ON						
<b>NORMAL "PAY" MODE</b>			OFF						
COIN(S)	CREDIT(S)					OFF	OFF	OFF	OFF
1	1					OFF	ON	OFF	OFF
2	1					ON	OFF	OFF	OFF
3	1					ON	ON	OFF	OFF
4	1					OFF	OFF	OFF	ON
1	2					OFF	ON	OFF	ON
2	2					ON	OFF	OFF	ON
3	2					ON	ON	OFF	ON
4	2					OFF	OFF	ON	OFF
1	3					ON	OFF	ON	OFF
2	3					ON	ON	ON	OFF
3	3					OFF	OFF	ON	ON
4	3					ON	ON	ON	OFF
1	4					OFF	ON	ON	ON
2	4					ON	OFF	ON	ON
3	4					ON	ON	ON	ON
4	4					ON	ON	ON	ON

**4 POSITION SWITCH LOCATION J19**

STARTING CHARACTERS		SWITCH NUMBERS			
		1	2	3	4
3				OFF	OFF
2				OFF	ON
4				ON	OFF
5				ON	ON
<b>GAME PLAY DIFFICULTY</b>					
1 EASY		ON	ON		
2 NORMAL (Factory Setting)		OFF	OFF		
3 HARD		OFF	ON		
4 MOST DIFFICULT		ON	OFF		







# ame Description

## GENERAL

Crossbow™ by Exidy is an adventure shooting game. The player, armed with a crossbow, is escorting a party of characters (men, women, and dwarves, Etc.) through various dangerous episodes. The object of the game is to protect these characters from dangers lurking within each level, to remove obstacles impeding their progress, and reach the evil master's dungeon. This is all accomplished by shooting a myriad of colorful targets.

## Crossbow™

### HAS FIVE MODES OF OPERATION

SYSTEM DIAGNOSTIC MODE

MANUAL DIAGNOSTIC MODE

ATTRACT MODE

READ-TO-PLAY MODE

PLAY MODE

To bypass all diagnostics on power up, press Crossbow trigger.

### THE SYSTEM DIAGNOSTIC MODE

This mode on powerup will automatically perform the following tests.

AUDIO TEST

RAM TEST

SCREEN RAM TEST

CRC OF PROGRAM ROMS

CHECKSUM OF BANK ROMS

### MANUAL DIAGNOSTIC MENU MODE

To access Manual Diagnostic Mode hold down the Start Button ON POWER UP. Once this mode is accessed any of the listed menu selections may be indexed by the player Start Button and executed by the Crossbow trigger.

GUN ALIGNMENT

RAM TEST

SCREEN RAM TEST

CRC CHECK PROGRAM ROMS *A1, 2, 4, 6*

CHECK SUM BANK ROMS *A1, A2, A3, A4*

AUDIO TEST

CHECK INTERRUPTS

GRAY SCALE

CROSSHATCH

COLOR BARS AND BLOCKS

OPTICAL ADJUSTMENT

RESET TO FACTORY SETTINGS OF VANITY MODE AND GUN SIGHT.

EXIT

## ATTRACT MODE

The attract mode appears after power up diagnostics are successful and after every game. This mode will display these screen images repeatedly until a coin is inserted.

HIGH SCORE TABLE

DESERT OR VILLAGE GAME SCENE

CROSSBOW LOGO WITH COIN  
INSTRUCTIONS

CROSSBOW GAME INSTRUCTIONS

## READY-TO-PLAY MODE

The game is set into Ready-to-Play mode immediately after the coin or coins are inserted. The screen will still be in the Attract Mode Ready for Play.

## PLAY MODE

Press the Start Button, the screen will display the game maps, and two or three colored boxes, Red, Green & Blue (Ref. Fig. 2-3). Each scene is begun by the player firing the Crossbow at a colored box and choosing the colored path he wishes his party to follow. If the party survives that level the player chooses where to go next by trial and error. The player must learn which colored path leads to each scene's unique element of danger. The adventure ends when all party members are killed.

Points are awarded for each target shot and are based on its difficulty level to be hit, bonus points are given at the end of each level for each surviving party member.

Surviving certain very difficult levels also awards the player with bonus members, increasing the size of his party.

Valuable treasures can be found in some scenes. The final goal is the Evil Master's Lair.



Figure 2-1 PLAY MODE SCREEN DISPLAY



NAIL

HAA 1/4 LEFT

LOOSE RIGHT

## CROSSBOW™ STOCK INSTALLATION

### MECHANICAL

CROSSBOW™ stock is detached from the forestock for shipping.

To install CROSSBOW™ stock, proceed as follows:

- a). Locate the 3 mounting screws.
- b). Check that the gun optic PCB connector is in place.
- c). Loosen the 8/32 set screw (see fig 1).
- d). Gently place CROSSBOW™ stock onto forestock mount.
- e). Secure CROSSBOW™ stock with (2) 10x24x5/8 button head screws, and (1) 1/4x20x2 3/8 cap screw to forestock (see fig 1).

### ELECTRICAL

CROSSBOW™ sight alignment procedure.

This alignment is performed whenever the CROSSBOW™ stock is removed, disassembled or if accuracy of alignment is required.

Proceed as follows:

- a). Turn off game. Wait approximately 3 seconds.
- b). While holding down the START BUTTON, power up game.
- c). When MANUAL DIAGNOSTIC MODE MENU is displayed release start button.
- d). Depress start button to move index pointer to OPTICAL ADJUSTMENT MODE.
- e). Press gun trigger to enter the OPTICAL ADJUSTMENT MODE.
- f). Aim the gun to approximately the center of the screen, a yellow rectangular pattern should be displayed.
- g). If the pattern is not rectangular rotate optical tube until best rectangular pattern is obtained.
- h). Check that approximately 1/4" of optical tube is beyond crossbow, TIGHTEN DOWN THE 8/32 SET SCREW on the left side of the Forestock (See Fig.1).
- i). Repeat steps A,B,C.
- j). Depress start button to move index pointer to GUN SIGHT ALIGNMENT TEST.
- k). Press gun trigger to enter the GUN SIGHT ALIGNMENT MODE. A crosshair (+) will be displayed.
- l). Align gun sight to the center of crosshair.
- m). While holding down gun trigger, a pulsing gun burst will appear at the center of the display. This burst verifies the gun circuit is operating normal. Release the trigger when the gun sight and burst are aligned. The gun sight will be calibrated to this last burst. NOTE: Shooting accuracy is dependent upon this calibration.
- n). Press start button and return to MANUAL DIAGNOSTIC MENU.
- o). Release start button.
- p). Again using the start button, index the pointer to EXIT.
- q). Press the gun trigger to return game to the ATTRACT MODE.

(OVER)



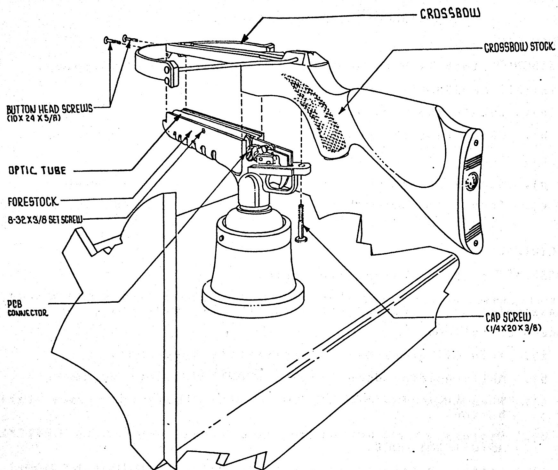

Fig-1 CROSSBOW STOCK INSTALLATION

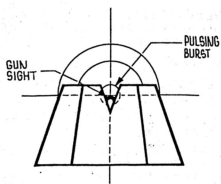

Fig-2 GUN SIGHT ALIGNMENT





390 JAVA DRIVE,

SUNNYVALE,

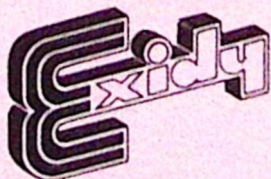

CALIFORNIA 94089 Tel. (408) 734-9410

Toll-free: (800) 538-8402  
Telex: 357-499 (EXIDY MNTV)